



ОЛІМПІЯ – ЧЕРВОНИЙ ХРЕСТ
OLYMPIA – KRASNYI KREST

Ортопедичні хірургічні інструменти

Orthopedic surgery
instruments

Каталог
Catalog

2013

“Олімпія – Червоний Хрест” – провідна українська фірма-виробник медичного інструментарію. Заснована в 1991 році.

Інструментарій розроблений та виготовлений досвідченими спеціалістами нашого підприємства, відповідає всім міжнародним стандартам (сертифікація проведена за системою **ISO 9001**).

Секрет нашого успіху полягає в тому, що поряд із прогресивними технологіями використовуємо сталь з високим вмістом хрому (на робочі частини) та кращі зразки текстоліту.

Творча діяльність фірми тісно пов'язана з Українським науково-дослідним інститутом травматології та ортопедії (м. Київ) та Київським міським ортопедичним центром ендопротезування. Найважливіші теми науково-дослідних робіт, більшість яких запатентовано, здійснюються під керівництвом провідних науковців.

“Olympia – Krasnyi Krest” – is a leading Ukrainian company producing medical instruments (founded in 1991).

The tools which are designed and produced by the skilled specialists of our enterprise meet all international standards (the certification was carried out according to **ISO 9001** level).

The secret of the succes lies in the use of stainless steel with high content of chromium (for the working parts of the instruments) and the best quality of textolite alongside with the progressive technologies

The creative activity of our enterprise is closely connected with the Ukrainian scientific-research Institute of traumatology and orthopedy (in Kyiv) and Endoprosthesis Centre Kyiv.

БУДЬ-ЛАСКА, УВАГА!

- 1. РУЧНА РОБОТА!**
- 2. ВИСОКА ЯКІСТЬ, НИЗЬКІ ЦІНИ!**
- 3. ОДИН РІК ГАРАНТІЇ БЕЗ ПЕРЕЗАТОЧКИ, незалежно скільки операцій Ви зробите за цей період**

ATTENTION, PLEASE!

- 1. HAND MADE!**
- 2. HIGH QUALITY, LOW PRICES!**
- 3. ONE YEAR OF GUARANTEE WITHOUT SHARPENING, regardless of the quantity of operations you make during this period of time**

ПАНОВЕ! Якщо Вас зацікавила інформація про запропонований у цьому каталозі високоякісний інструмент для ортопедії та травматології, ми раді співпрацювати з Вами.

Ми готові розглянути пропозиції співпраці щодо виготовлення медичного інструментарію на ваше замовлення

З повагою директор фірми
«ОЛІМПІЯ – ЧЕРВОНИЙ ХРЕСТ»
Володимир ДАВИДЕНКО

GENTLEMEN! If you are interested in the information about the highquality tools for orthopedy and traumatology, offered in this catalogue, we'll be glad to cooperate with you.

We are ready to consider your proposals while producing the tools if you make the orders for our tools.

Yours sincerely, the director of the firm
«OLYMPIA – KRASNYI KREST»
Volodymyr DAVYDENKO



тел./факс :: tel./fax
+380 352 52-09-74
моб. :: mob.
+380 50 377-08-25



Набір інструментів для остеотомії таза

Instruments kit for pelvic osteotomy

RP-1
335/15mm



RP-2
335/15mm R20



RP-3
335/15mm



RP-4
330/20mm

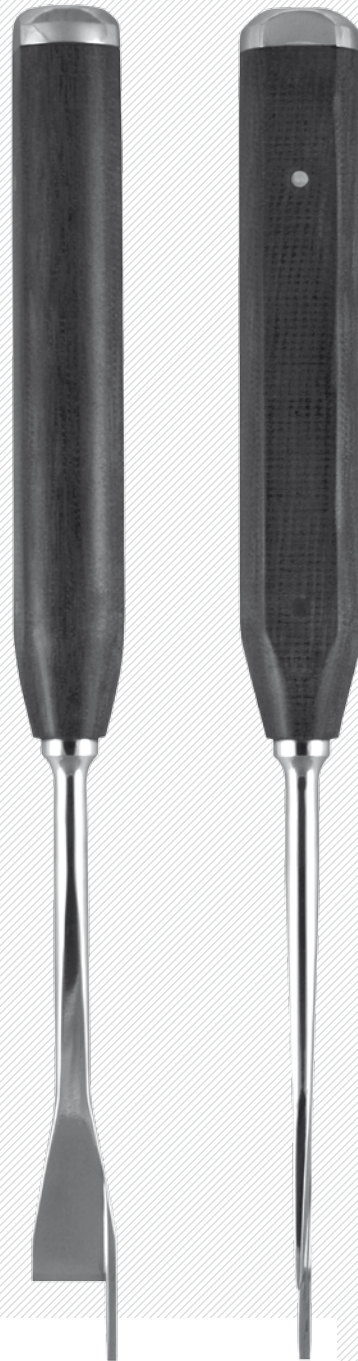

RP-5
330/15mm R7.5

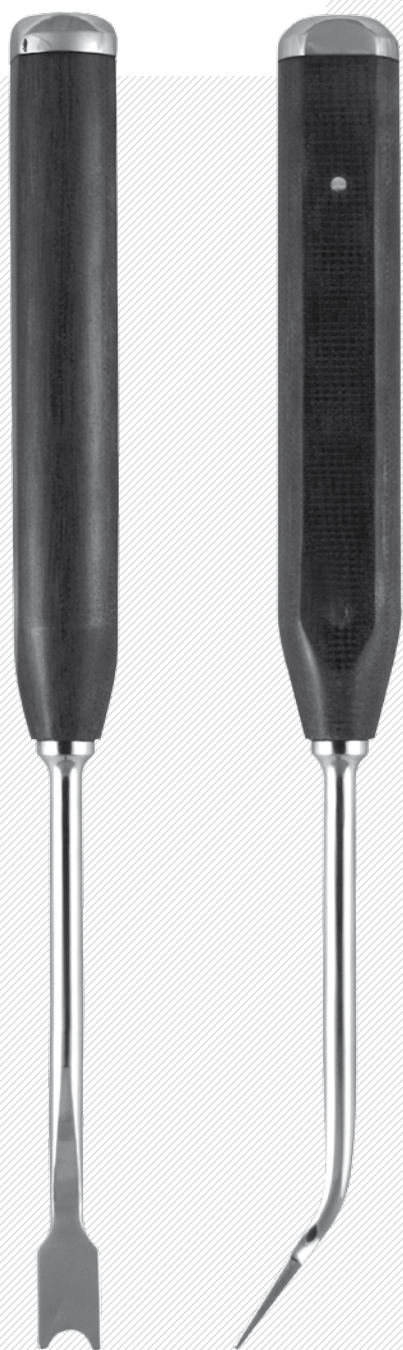

Вид ззаду
Back side view



RP-6
330/15mm R10

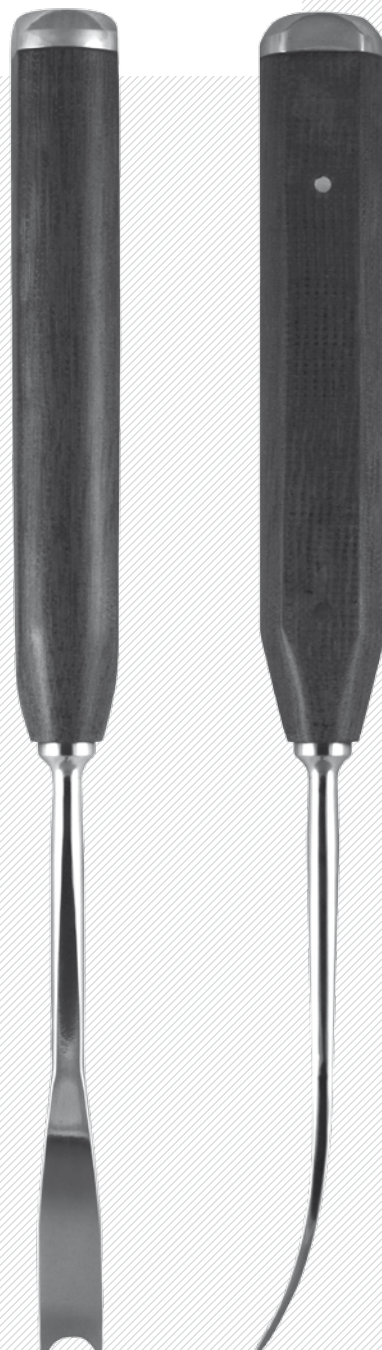

Вид ззаду
Back side view

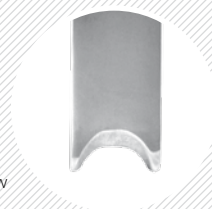



R-1a
200/15mm

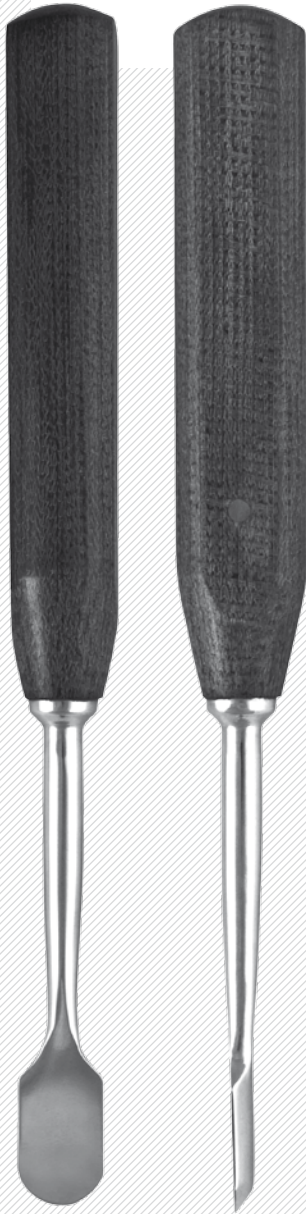

R-3a
200/15mm R25

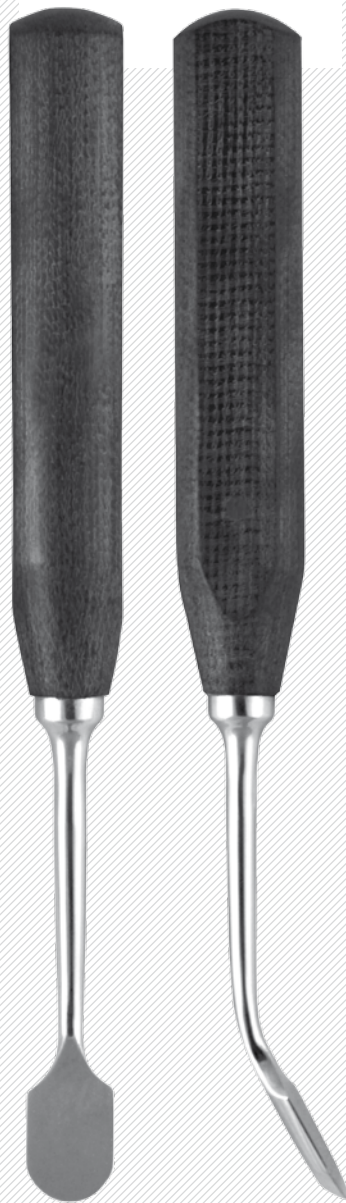

RM-5a
188/6mm

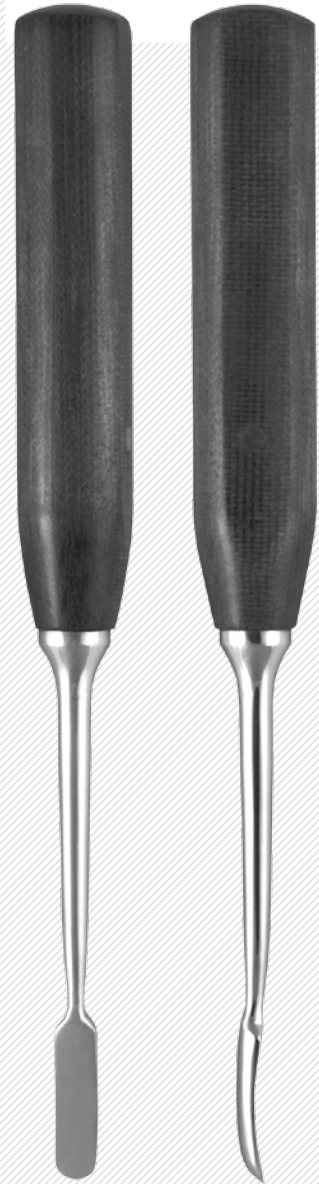

Вид ззаду
Back side view



Вид ззаду
Back side view



Распатор Вальбжих
Raspatory Walbrzych

Распатор Вальбжих

Raspatory Walbrzych

www.okkd.com.ua

RVO
260/6mm





Кісткові елеватори Hohmann

Bone levers Hohmann

HL
240/42/40mm



HL1
240/42/60mm



HL1a
340/42mm

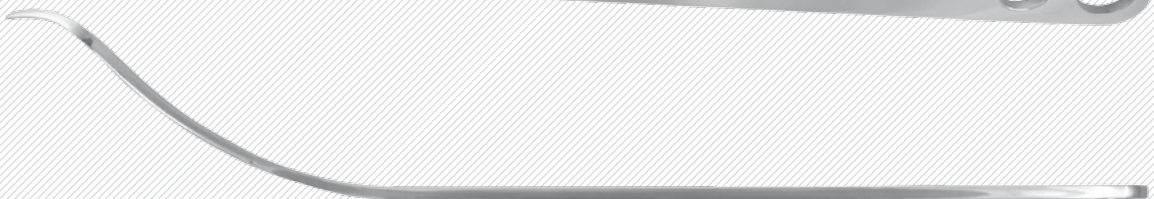

HL2
250/70mm

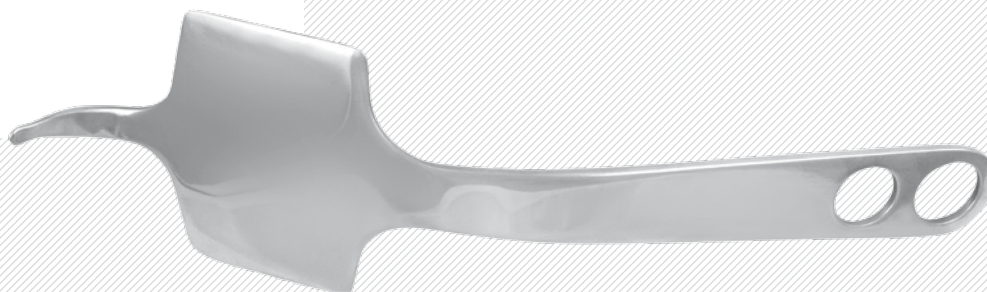

HL3
230/8mm





HL4
260/22mm



HL5
350/36mm

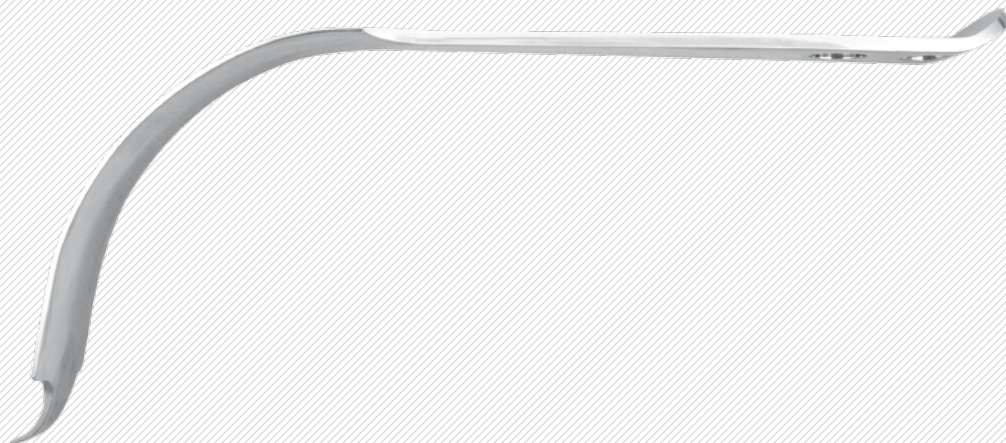

HL6
245/42mm



HL7
245/42mm





HL8
220/8mm

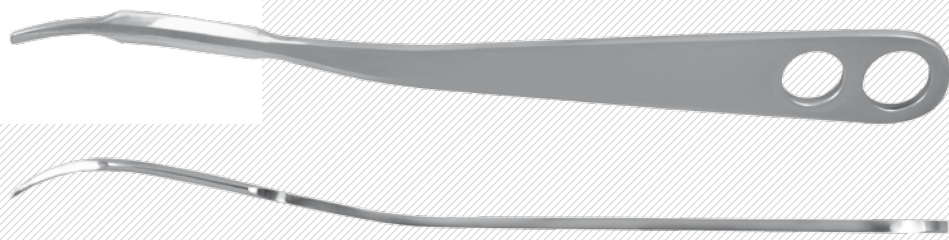

HL9
240/18mm

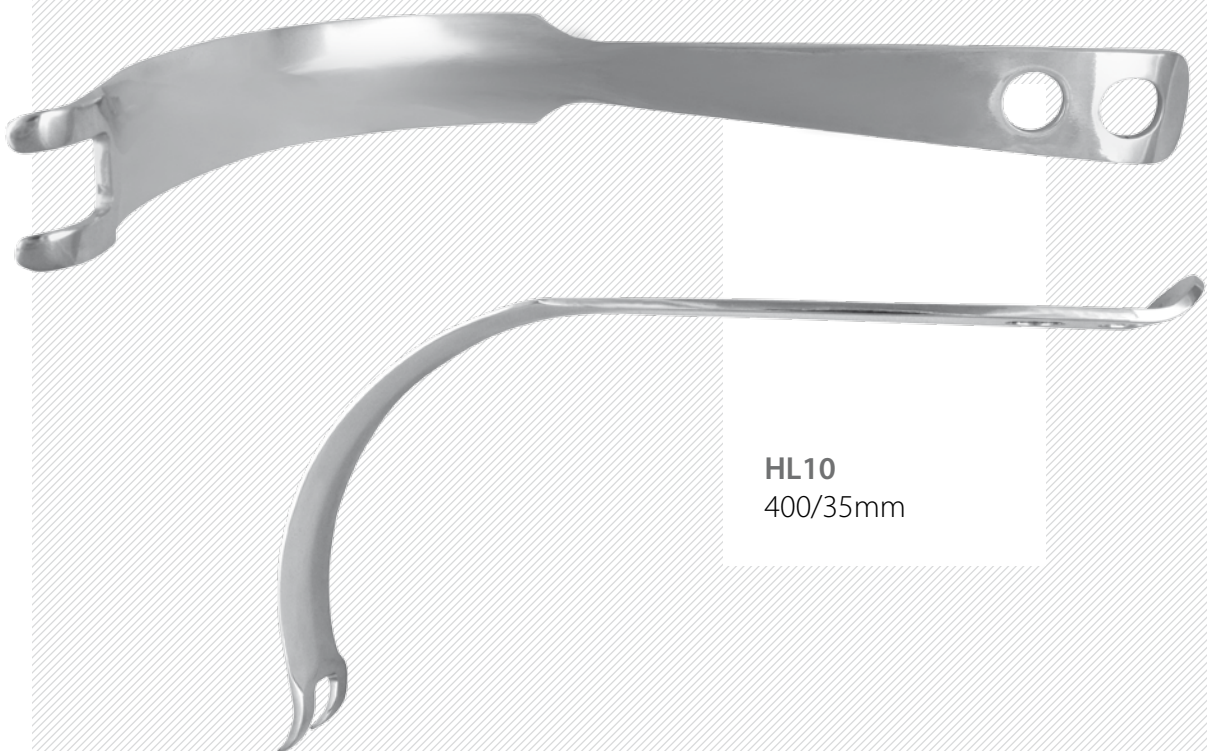

HL10
400/35mm

HL11
350/22mm

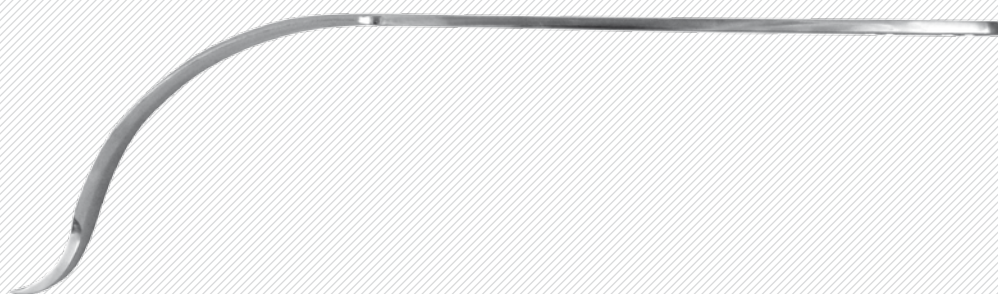

HL12
340/22mm

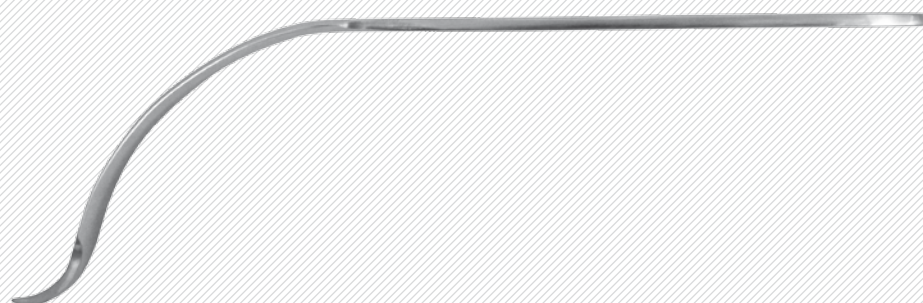



HL13
330/22mm

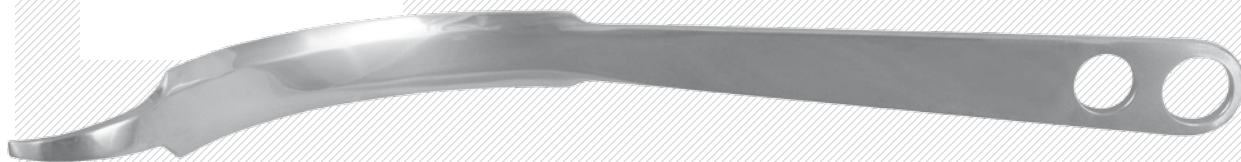

HL14
250/20mm



HL15
240/20mm



HL16
240/30mm





HL17

245/18mm

215/18mm



HL18

250/18mm

220/18mm



HLb
340/20mm



HLc
240/25mm





LLH
220/22mm



Вид ззаду
Back side view

LLHa
300/22mm



HLW
250mm
1kg

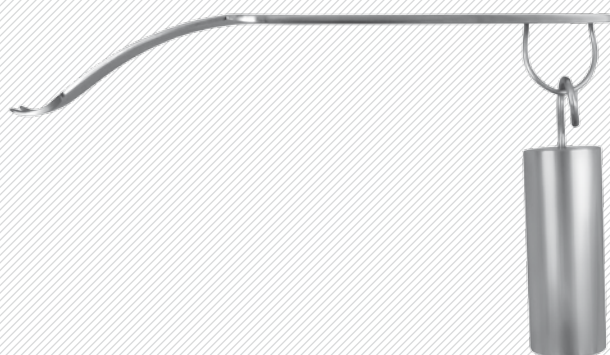
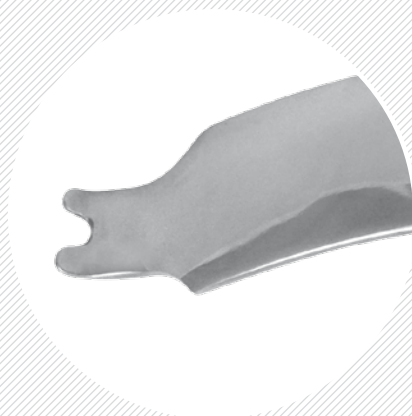
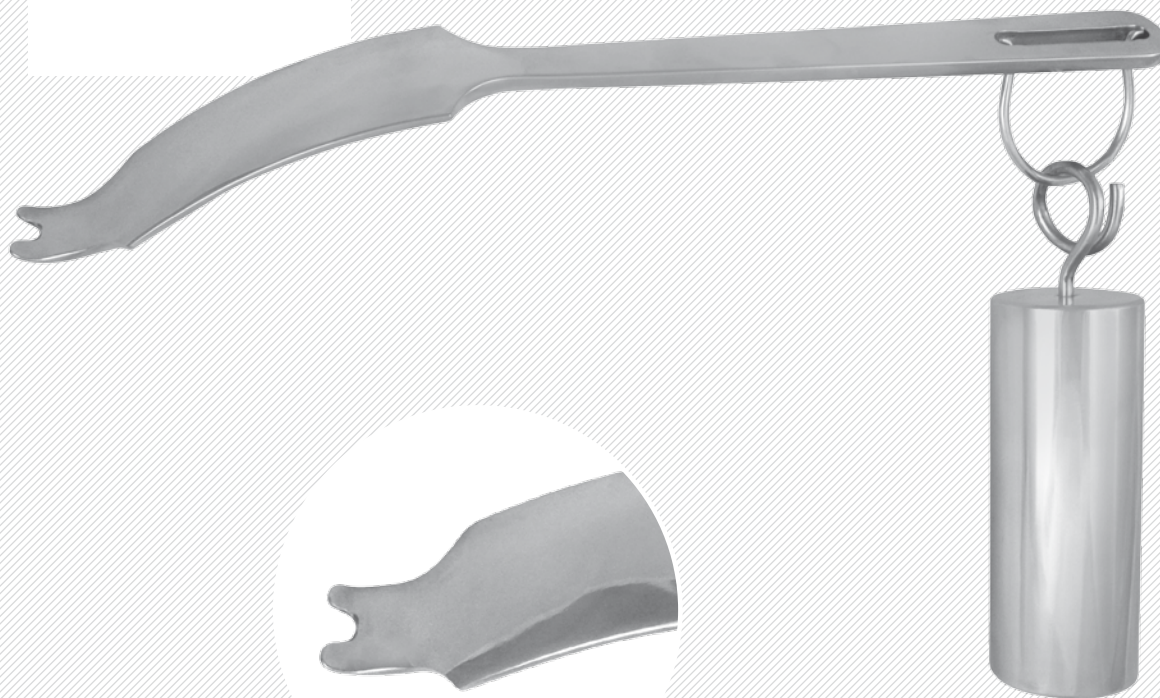



HG1
300/200/30mm



HG2
300/200/30mm

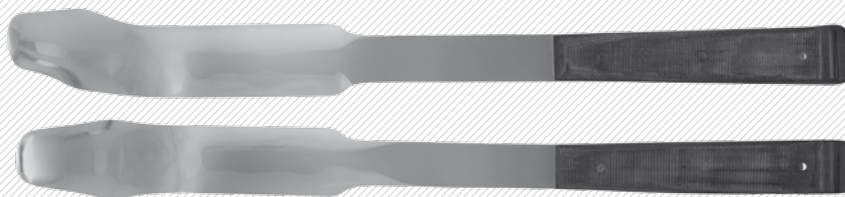



Кісткові елеватори та ретрактори

Bone levers and retractors

www.okkd.com.ua



RD1
300/36mm

Ретрактор Deaver
Retractory Deaver



RD2
360/36mm

Ретрактор Deaver
Retractory Deaver





BL1
150/2.8mm



BL2
150/7mm



BL3
150/5mm



RT1
150/9mm

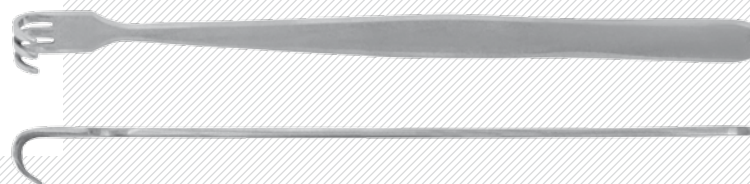

RT2
150/6mm

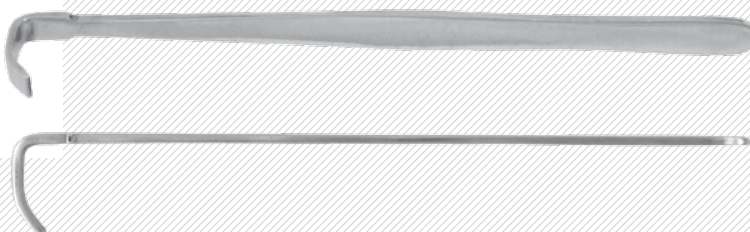

RT11
260/60mm

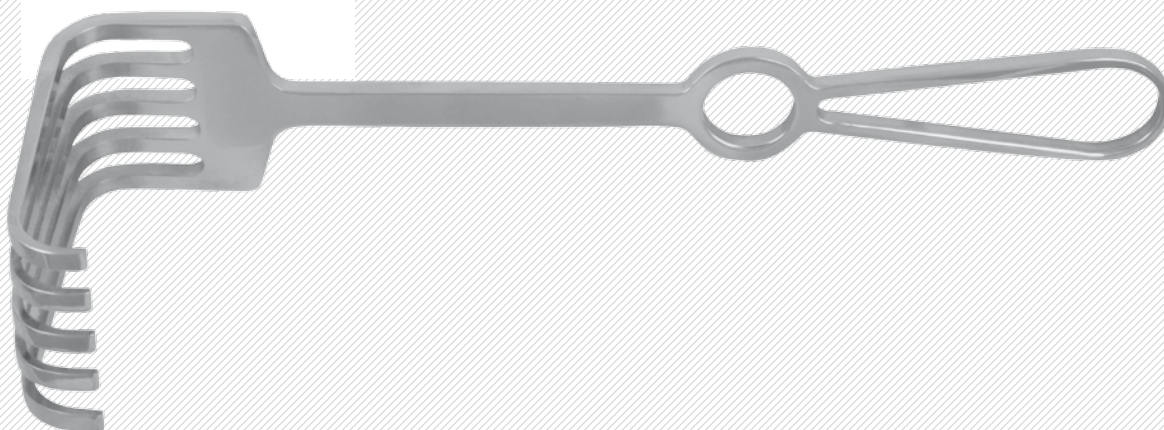

RT12
270/70mm

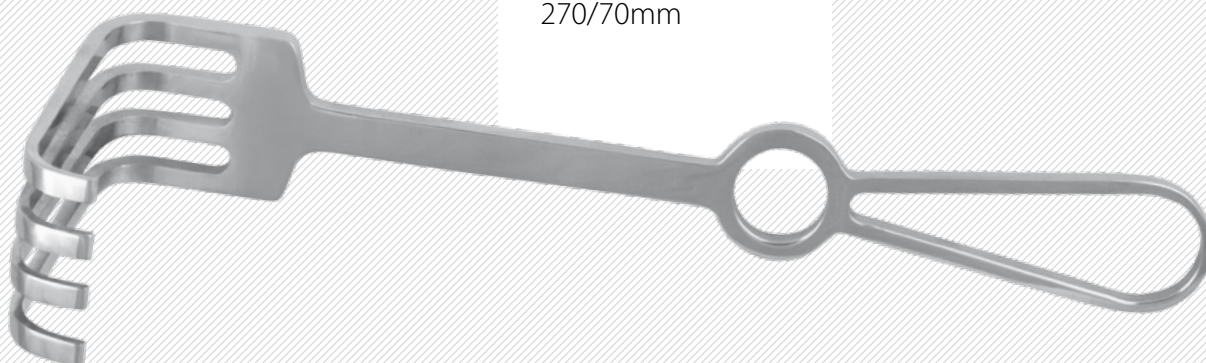

Рамка Charnley

Charnley frame

HGH
250/240mm



Повний набір
Full set

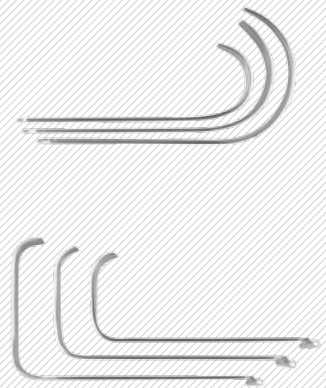
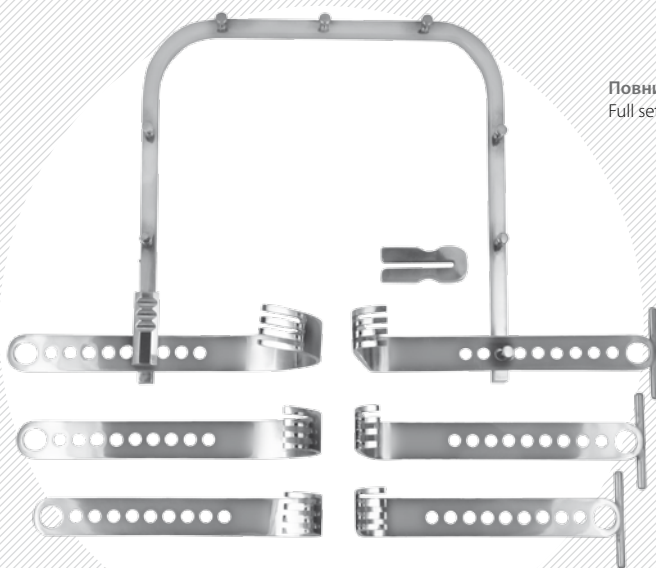

Шило Reamery

RM51
235/1,5mm



RM71
335/3mm

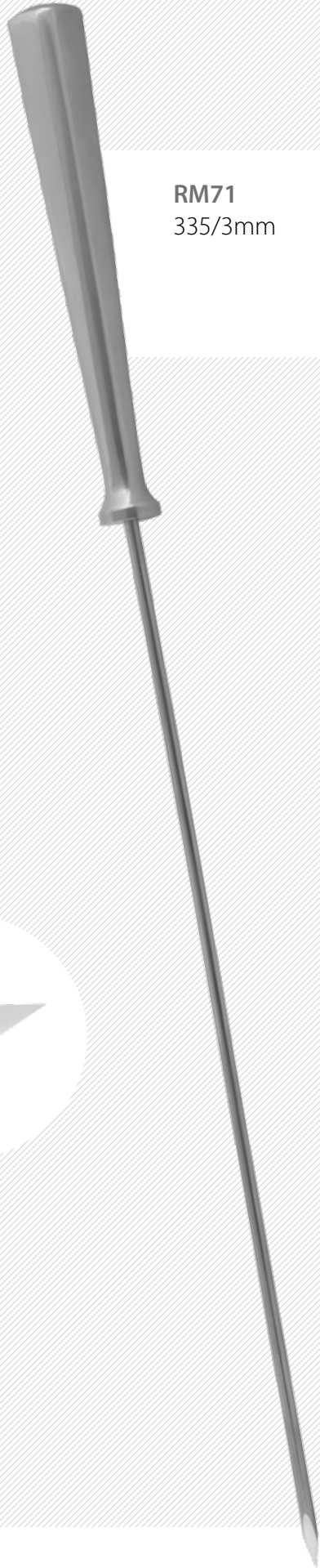

RM61
240/3mm



Geneva 2002



New York 2010



QC 100



Відгуки
Feedback

Цей інструмент супер. Це фантастика!

The tools are super,
this is fantastic!

Дрор Палей,
професор ортопедичної хірургії,
директор Балтиморського медичного центру,
Мериленд, США

Dror Paley, M.D. F.R.C.S.C.,
Medical centre of Baltimore



ОЛІМПІЯ – ЧЕРВОНИЙ ХРЕСТ
Ортопедичні хірургічні інструменти

OLYMPIA – KRASNYI KREST
Orthopedic surgery instruments



www.okkd.com.ua